

Quantum Information with Solid-State Devices

VO 141.246

SS2012

Dr. Johannes Majer

Lecture 7



$E_J=0$

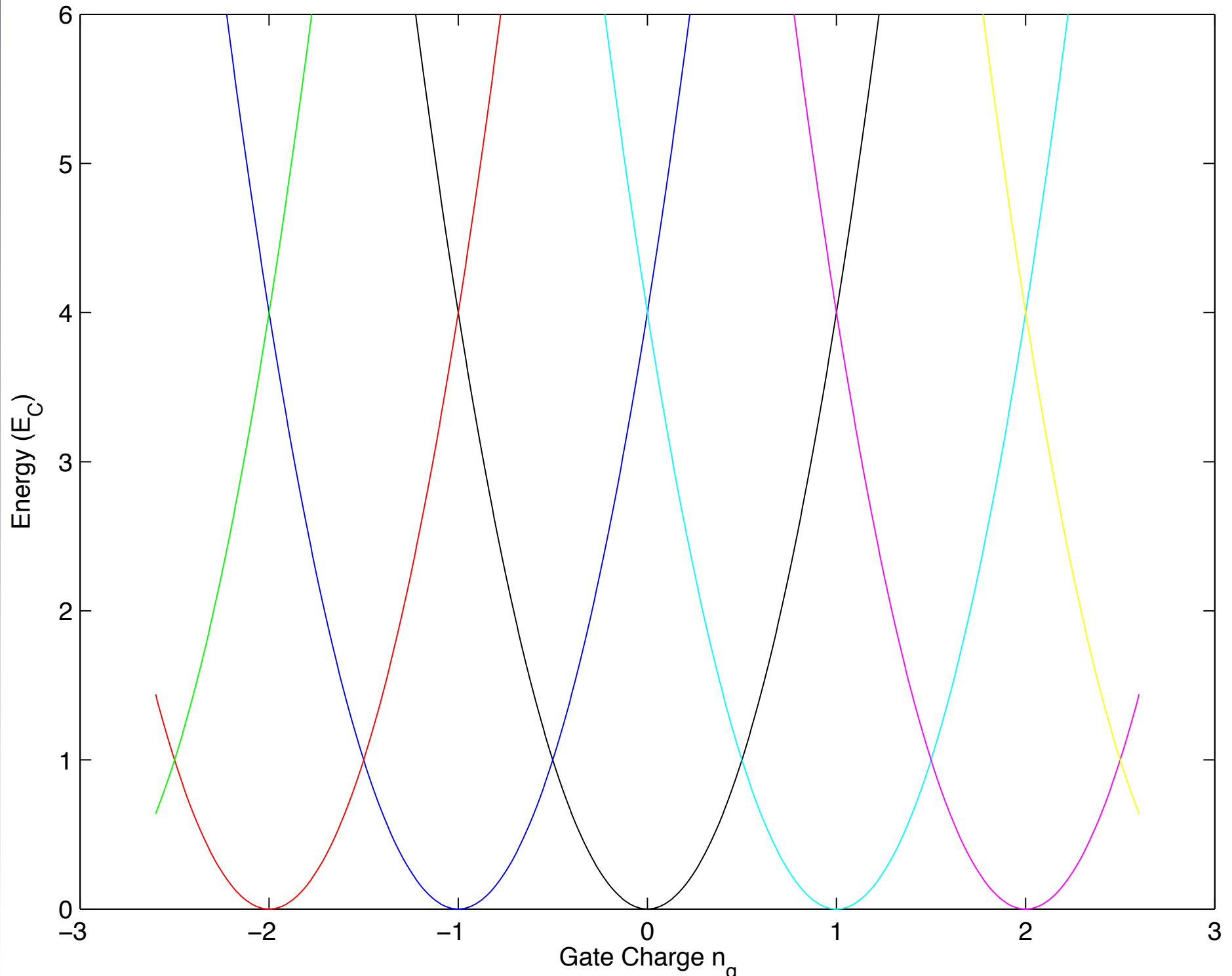

$$E_J/E_C=0.0$$

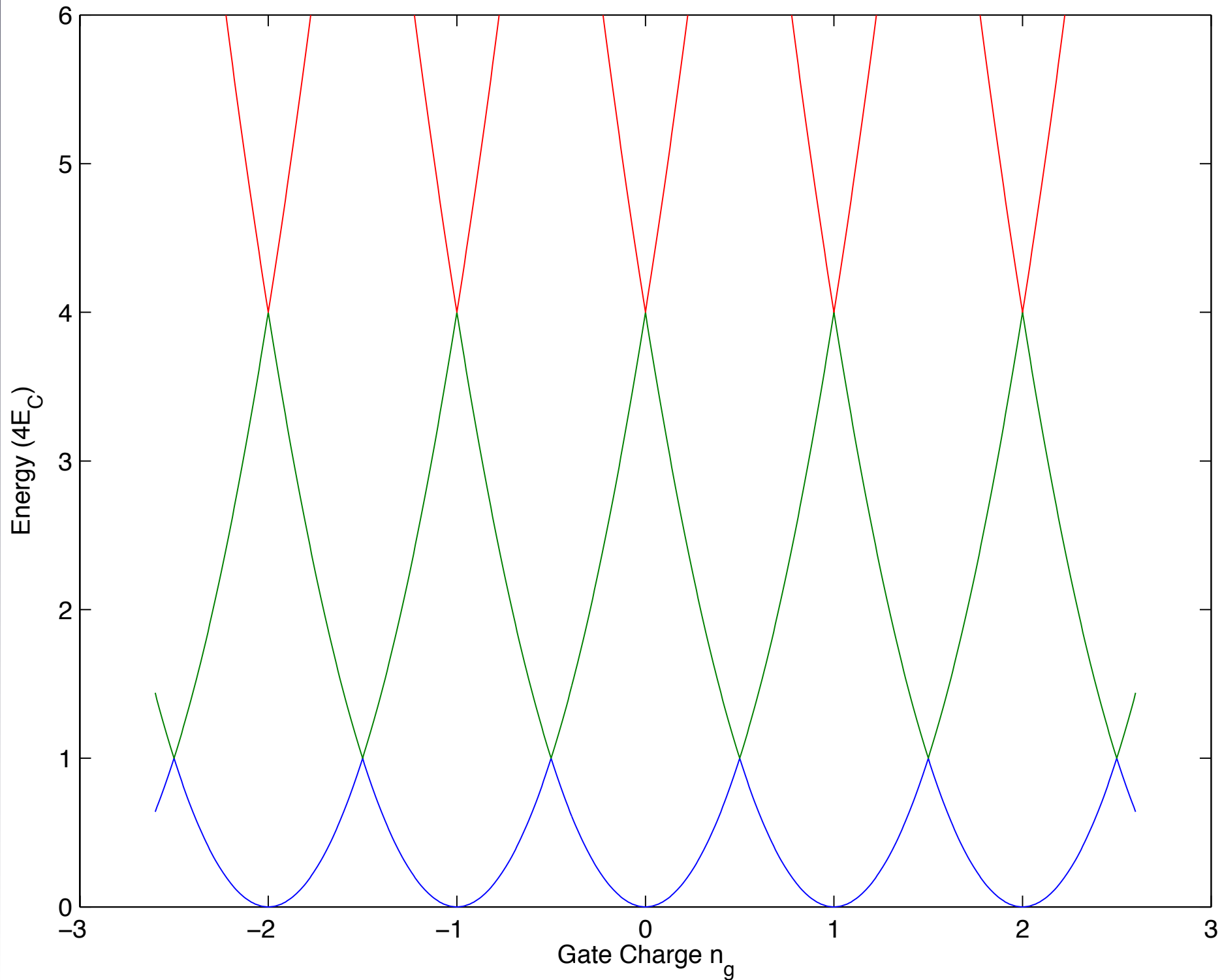

$$E_J/E_C = 0.1$$

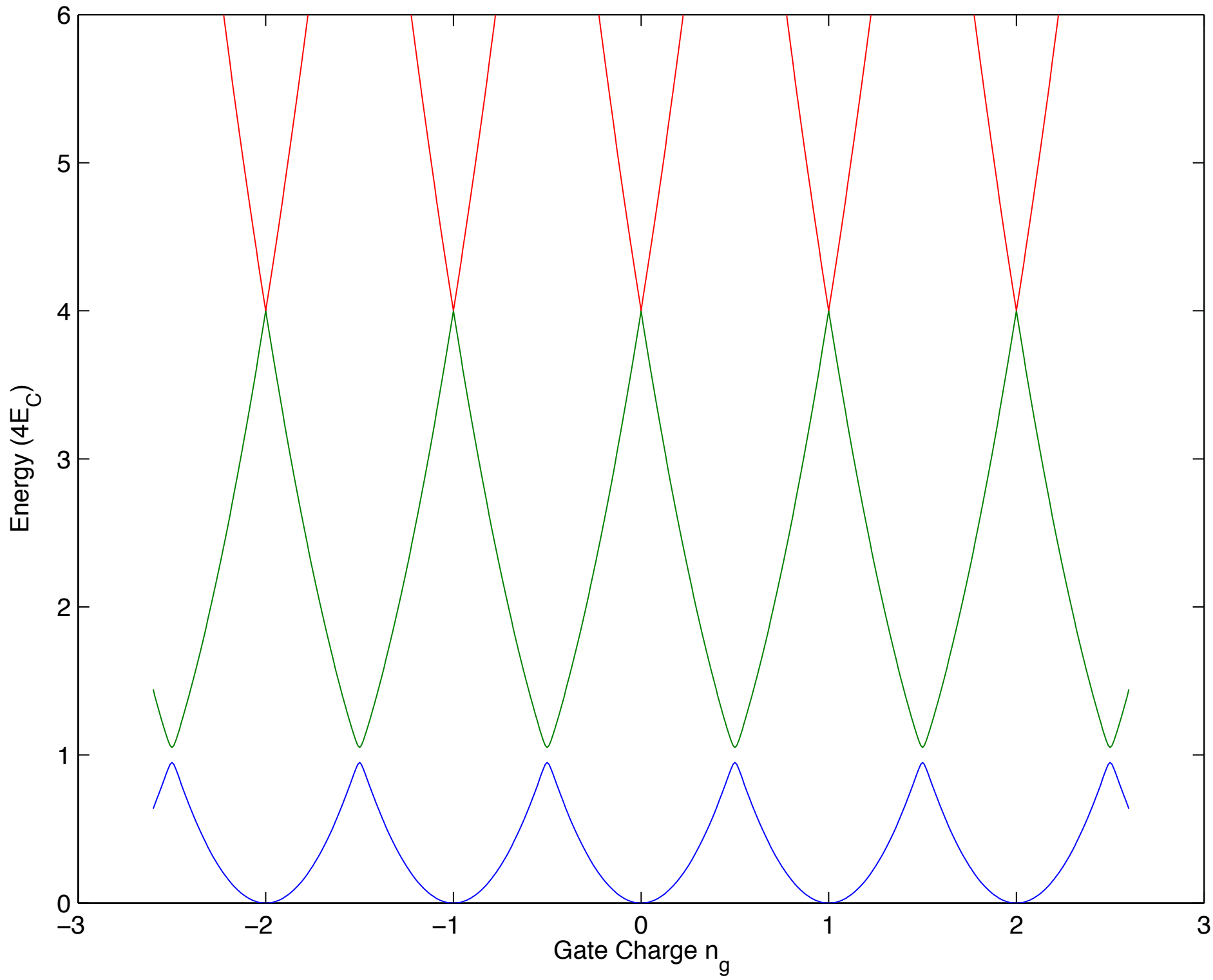

$$E_J/E_C=4$$

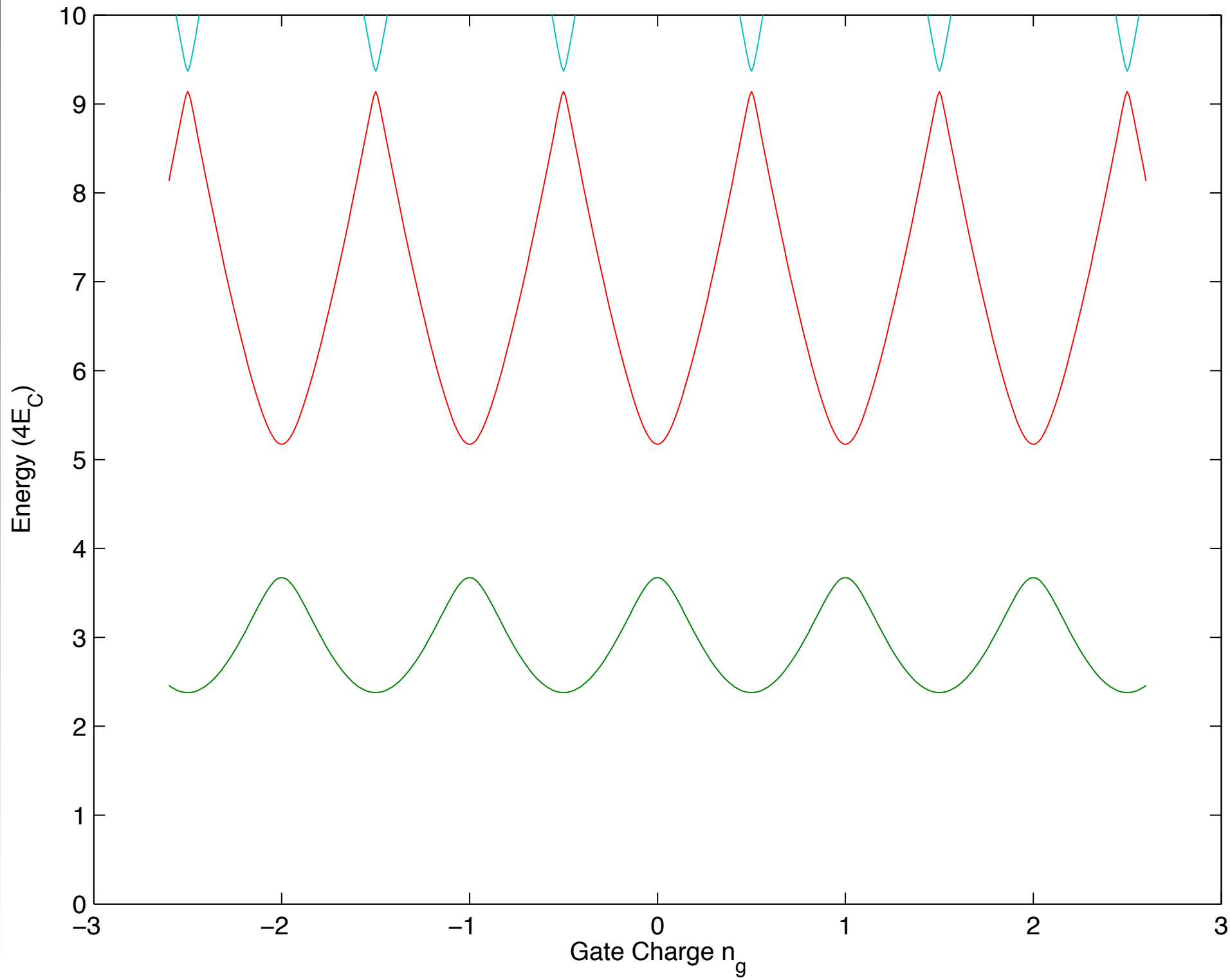

Two-electron quantization of the charge on a superconductor

P. Lafarge, P. Joyez, D. Esteve, C. Urbina & M. H. Devoret

Service de Physique de l'Etat Condensé, CEA-Saclay, F-91191 Gif-sur-Yvette, France

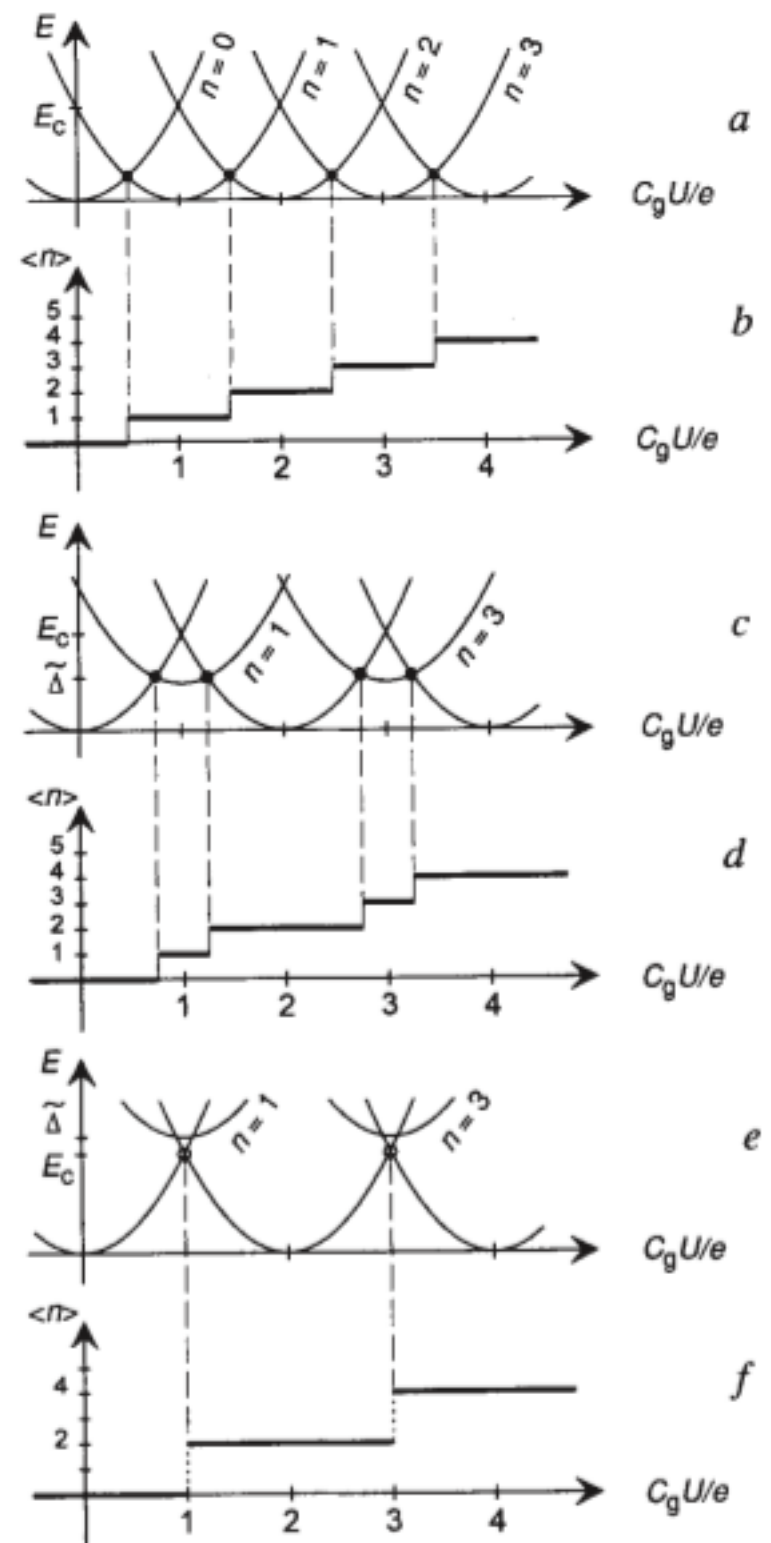
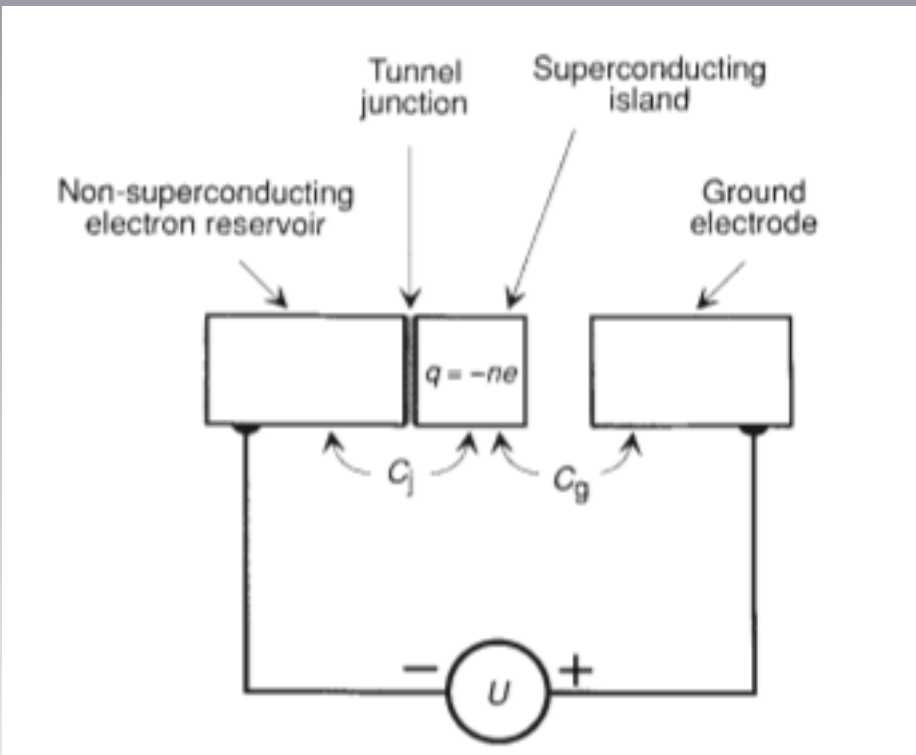

Two-electron quantization of the charge on a superconductor

P. Lafarge, P. Joyez, D. Esteve, C. Urbina & M. H. Devoret

Service de Physique de l'Etat Condensé, CEA-Saclay, F-91191 Gif-sur-Yvette, France

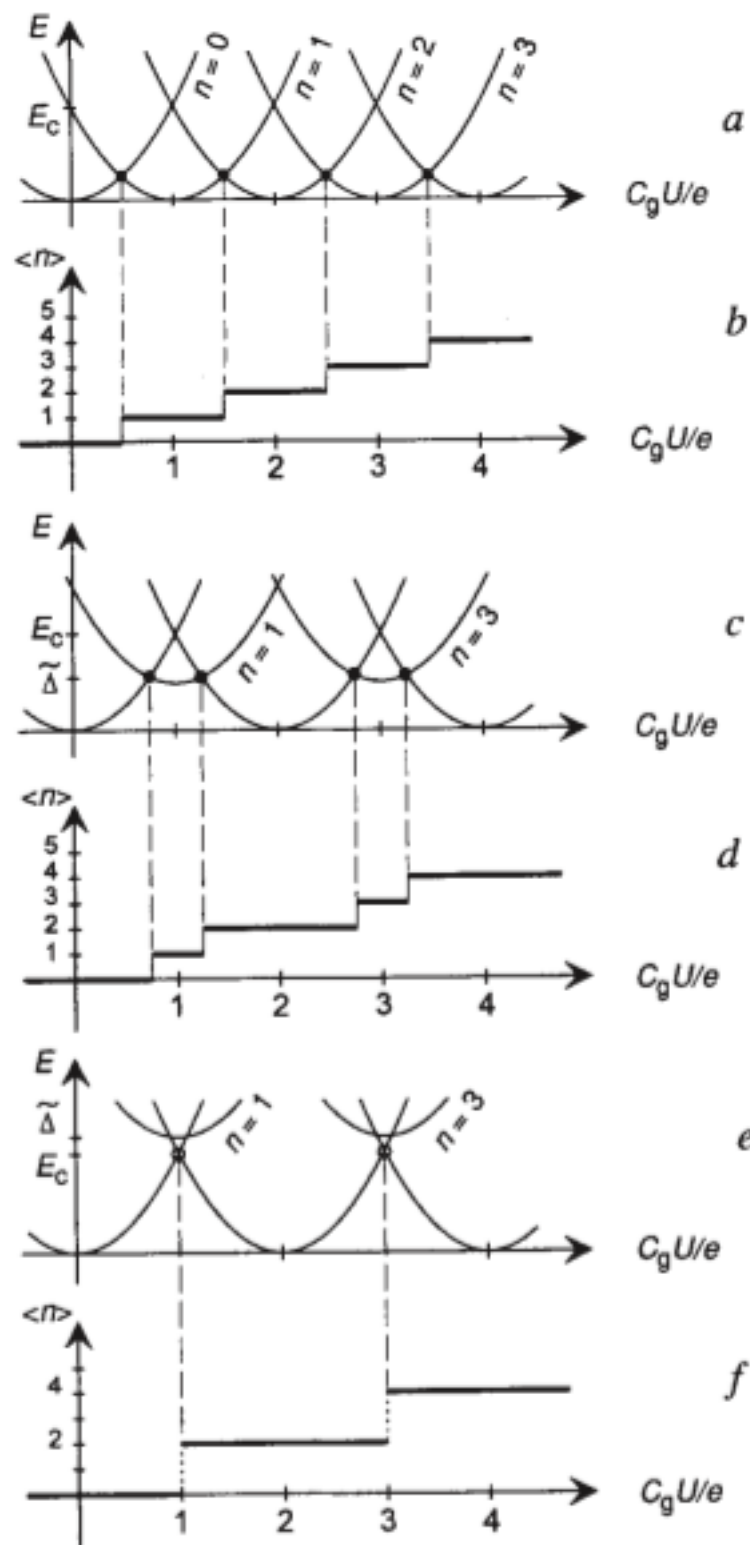
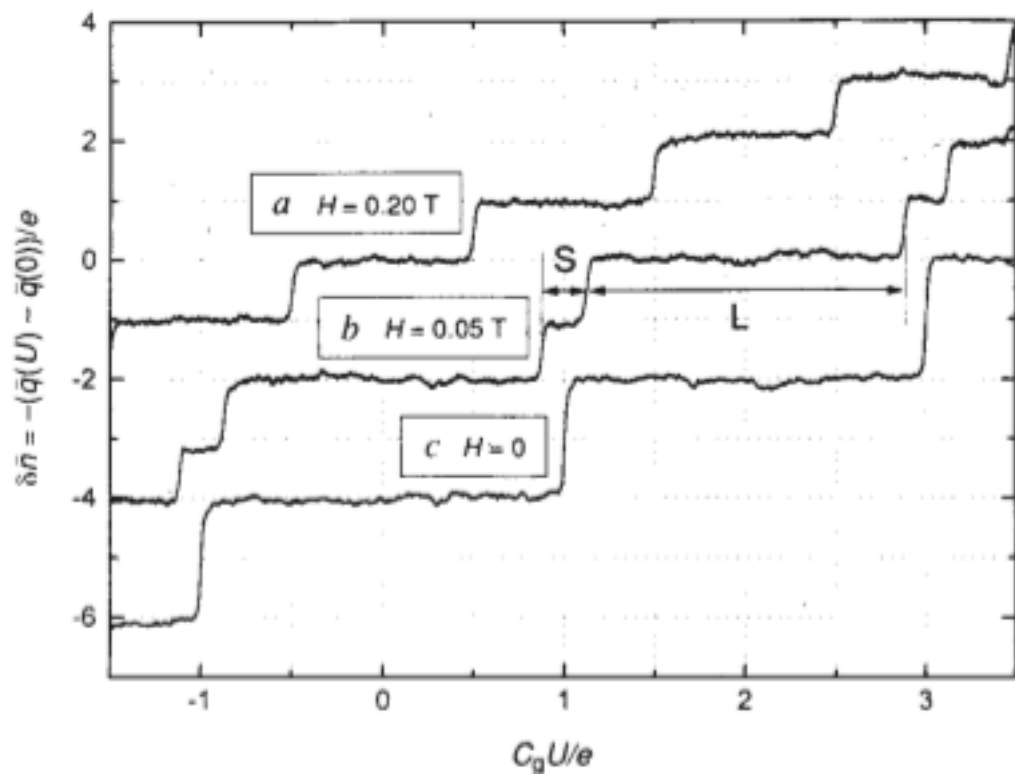

Backaction Effects of a SSET Measuring a Qubit Spectroscopy and Ground State Measurement

Benjamin Turek, Johannes Majer, Aashish Clerk, Steve Girvin, Andreas Wallraff, Kevin Bladh, David Gunnarsson, Tim Duty, Per Delsing, and Robert Schoelkopf

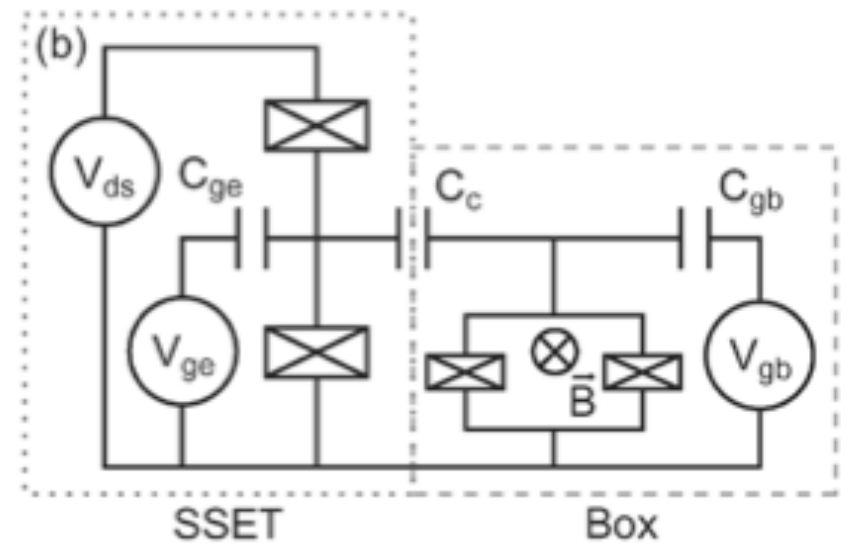
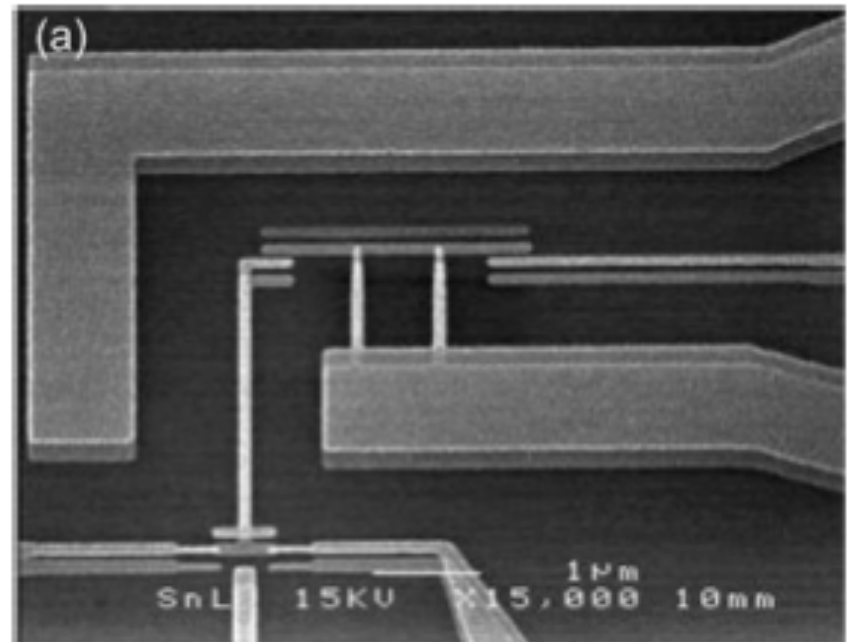
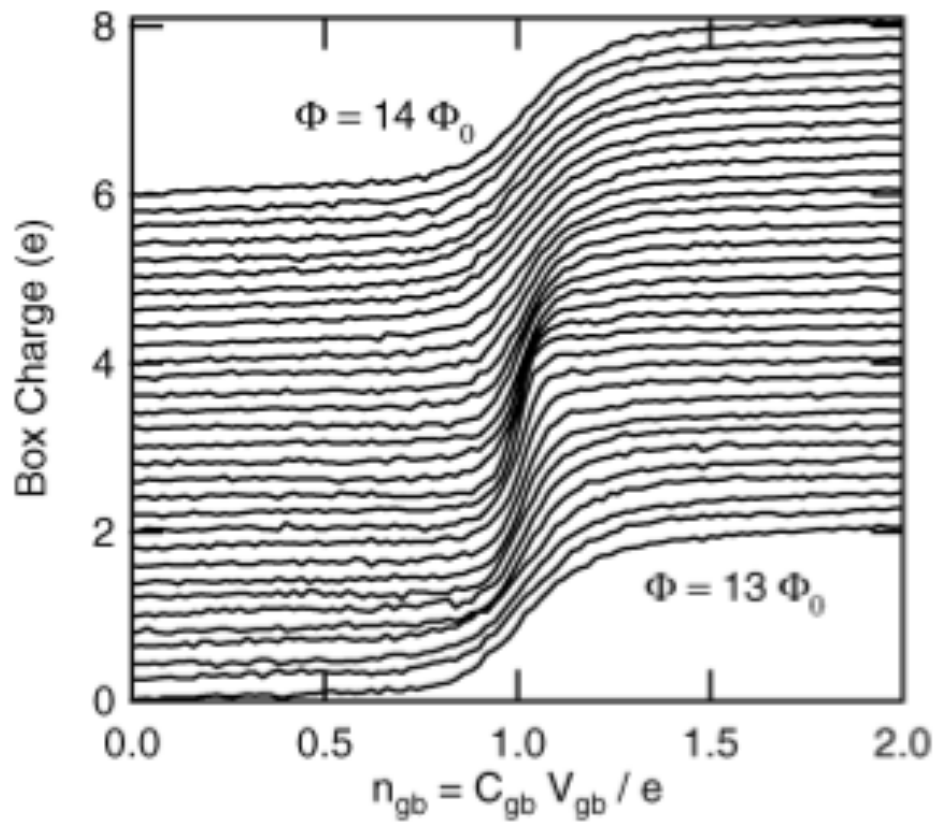

Backaction Effects of a SSET Measuring a Qubit Spectroscopy and Ground State Measurement

Benjamin Turek, Johannes Majer, Aashish Clerk, Steve Girvin, Andreas Wallraff, Kevin Bladh, David Gunnarsson, Tim Duty, Per Delsing, and Robert Schoelkopf

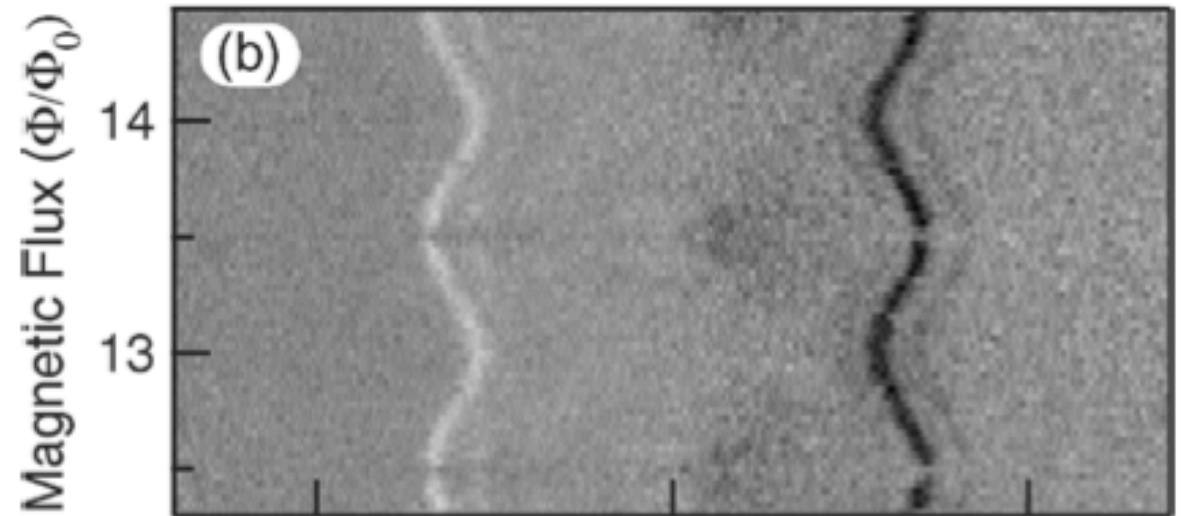
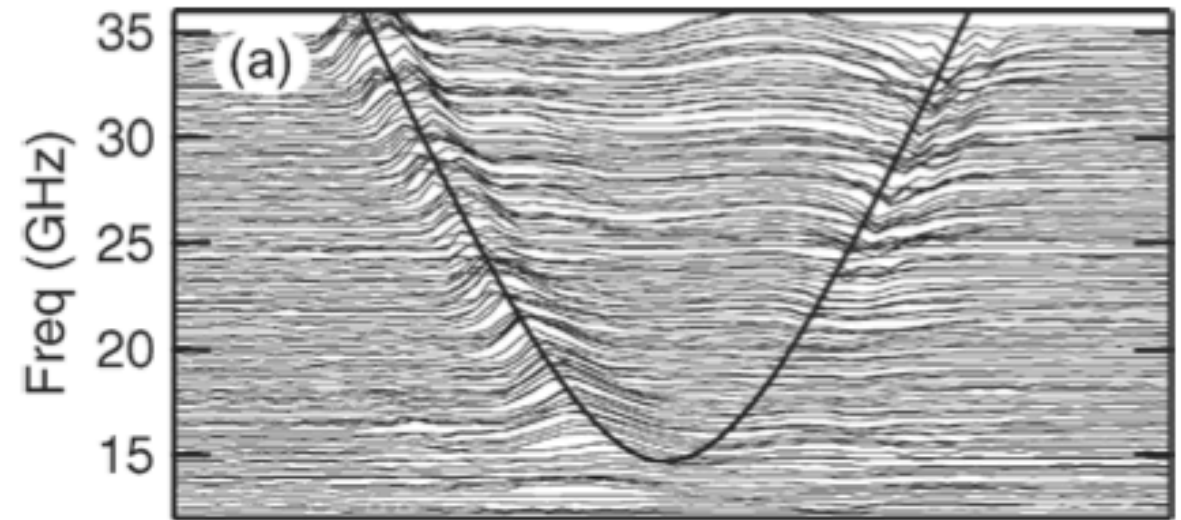

$$n_{gb} = C_{gb} V_{gb} / e$$

